

SLIDING VALVES SKT & SK TYPE Q-24

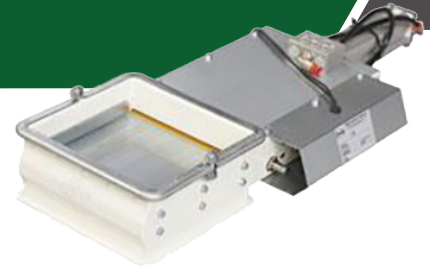

Sliding valves type SKT can be installed into a grain spout for the regulation or cutting off of the flow. The sliding valve type SKT is controlled by means of special internal guides ensuring that kernels are not broken. The sliding valve SKT is complete with VULKULAN™ sealing to minimise dust leakage.

The actuator on the sliding valve type SKT can be manually, motorised and pneumatically operated and is guarded and secured according to the EU machine directive.

The **sliding valves type SK** can be inserted into a grain spout for regulation or cutting off of the flow. The sliding valve is controlled by means of outside guides ensuring that kernels are not broken.

The manually operated and the rack and pinion sliding valve type SK comply with the EU machine directive.

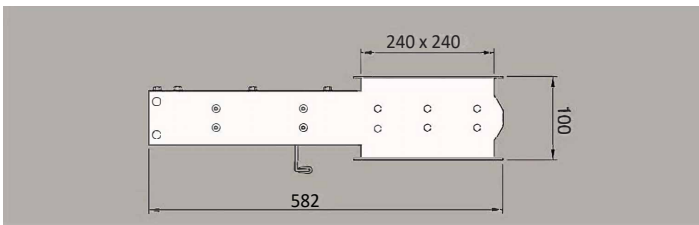

SKT72 Manual operated
SKT73 Manually operated with indication

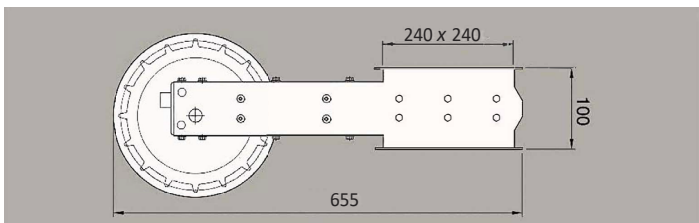

SKT74 Chain operated
SKT75 Chain operated with indication

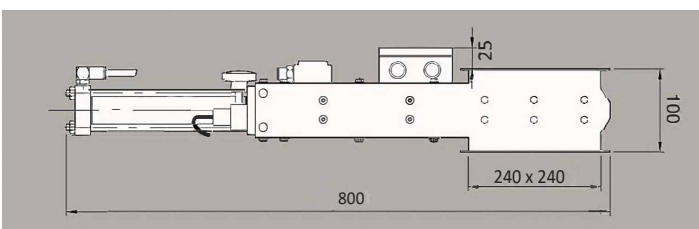

SKT77 Pneumatically operated with capact regulation
SKT78 Pneumatically operated

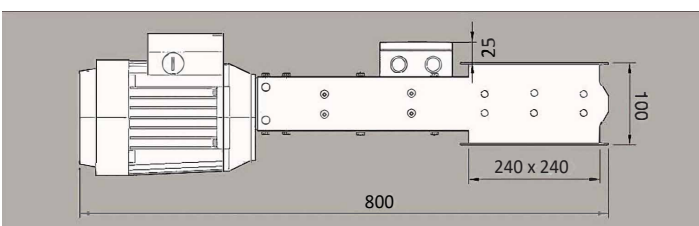

SKT79 Motorised

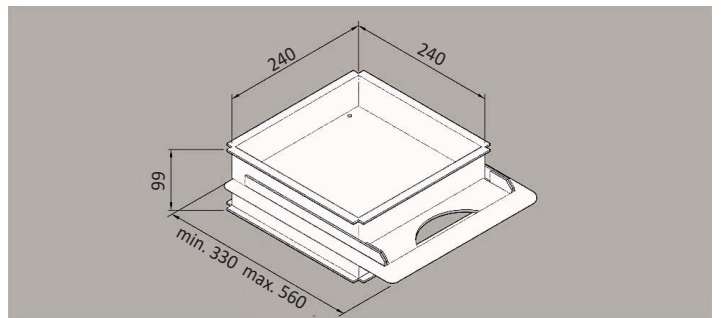

SK72 Manually operated

